

2023

TARIFA PVP

Edición septiembre

NIRON® *Clima*
Cool-pro™



Sistema de tuberías para circuitos de recuperación de condensados en torres de refrigeración

italsan

Índice

Sistema de tuberías y accesorios Sistema NIRON CLIMA COOL PRO

- 3 Gama de tubería
- 7 Accesorios termofusión
- 21 Portabridas
- 23 Bidas
- 25 Accesorios electrosoldables

Tubería compuesta NIRON CLIMA COOL PRO PP-RCT RA7050 CON PROTECCIÓN UV

Tubería compuesta PP-RCT RA7050 con protección de dióxido de titanio SDR11/Serie 5



Descripción

- Tubo compuesto PP-RCT RA7050+ FV SDR11/SERIE 5.
- Capa externa: Capa PP-RCT aditivado con masterbach resistente a radiación UV color blanco.
- Capa interna: PP-RCT RA7050+FV color gris.
- Clase 1/6 bar, clase 2/6 bar, clase 4/6 bar, clase 5/4 bar.

Suministro:

- En barras de 5,8 metros.

Aplicaciones



Referencia	∅	Espesor (mm)	L (m)	Metros/Bolsa	Palet (m)	Precio (€/m)
27TNIRCLUV329 *	32	3,6	5,8	87,0	1.914,0	8,11
27TNIRCLUV4011	40	3,7	5,8	58,0	1.160,0	9,87
27TNIRCLUV5011	50	4,6	5,8	29,0	812,0	14,34
27TNIRCLUV6311	63	5,8	5,8	23,2	510,4	22,33
27TNIRCLUV7511	75	6,8	5,8	17,4	348,0	29,72
27TNIRCLUV9011	90	8,2	5,8	11,6	232,0	44,27
27TNIRCLUV11011	110	10,0	5,8	5,8	162,4	67,83
27TNIRCLUV12511	125	11,4	5,8	5,8	116,0	83,58
27TNIRCLUV16011	160	14,6	5,8	5,8	69,6	146,23
27TNIRCLUV20011	200	18,2	5,8	5,8	46,4	228,26
27TNIRCLUV25011	250	22,7	5,8	5,8	29,0	351,60
27TNIRCLUV31511	315	28,6	5,8	5,8	17,4	564,92
27TNIRCLUV35511	355	32,2	5,8	5,8	17,4	685,95
27TNIRCLUV40011	400	36,3	5,8	5,8	17,4	933,84

* Descripción

- Tubo compuesto PP-RCT RA7050+ FV SDR9/SERIE 4.
- Capa externa: Capa PP-RCT aditivado con masterbach resistente a radiación UV color blanco.
- Capa interna: PP-RCT RA7050+FV color gris.
- Clase 1/8 bar, clase 2/8 bar, clase 4/8 bar, clase 5/6 bar.

Suministro:

- En barras de 5,8 metros.



Tubería compuesta NIRON CLIMA COOL PRO PP-RCT RA7050 CON PROTECCIÓN UV

Presiones de servicio tubería compuesta PP-RCT SDR11/Serie 5

		NIRON Compuesta PP-RCT SDR11/Serie 5		NIRON Compuesta PP-RCT SDR9/Serie 4	
Clase	1	6		8	
	2	6		8	
	4	6		8	
	5	4		6	
T máxima fluido (°C)	Años en ejercicio continuo	Presión servicio (bar)	Presión servicio (bar)	Presión servicio (bar)	Presión servicio (bar)
		Circuito abierto	Circuito cerrado	Circuito abierto	Circuito cerrado
10	1	19,0	22,8	24,0	28,8
	5	18,4	22,1	23,2	27,9
	10	18,2	21,9	22,9	27,5
	25	17,9	21,5	22,5	27,1
	50	17,7	21,2	22,2	26,7
20	1	16,6	19,9	20,9	25,0
	5	16,0	19,3	20,2	24,2
	10	15,8	19,0	19,9	23,9
	25	15,5	18,6	19,6	23,5
	50	15,3	18,4	19,0	23,1
30	1	14,3	17,2	18,1	21,7
	5	13,9	16,6	17,4	20,9
	10	13,6	16,4	17,2	20,6
	25	13,4	16,1	16,9	20,2
	50	13,2	15,8	16,6	19,9
40	1	12,3	14,8	15,5	18,6
	5	11,9	14,3	15,0	18,0
	10	11,7	14,1	14,7	17,7
	25	11,5	13,8	14,4	17,3
	50	11,3	13,6	14,2	17,1
50	1	10,5	12,6	13,3	15,9
	5	10,1	12,2	12,8	15,3
	10	10,0	12,0	12,6	15,1
	25	9,7	11,7	12,3	14,7
	50	9,6	11,5	12,1	14,5
60	1	8,9	10,7	11,2	13,5
	5	8,6	10,3	10,8	13,0
	10	8,4	10,1	10,6	12,7
	25	8,2	9,9	10,4	12,4
	50	8,1	9,7	10,2	12,2
70	1	7,5	9,0	9,4	11,3
	5	7,2	8,6	9,1	10,9
	10	7,0	8,5	8,9	10,7
	25	6,9	8,3	8,7	10,4
	50	6,8	8,1	8,5	10,2
80	1	6,2	7,5	7,9	9,5
	5	6,0	7,2	7,5	9,5
	10	5,9	7,0	7,4	8,9
	25	5,7	6,9	7,2	8,6
95	1	4,7	5,6	5,9	7,1
	5	4,4	5,3	5,6	6,7

Circuito abierto: Coeficiente de seguridad aplicado del 1,5 según norma UNE-EN ISO 15874

Circuito cerrado: Coeficiente de seguridad aplicado del 1,25 según norma DIN 8077/78

Tubería compuesta NIRON CLIMA COOL PRO PP-RCT RA7050 CON PROTECCIÓN UV

Tubería compuesta PP-RCT RA7050 con protección de dióxido de titanio SDR17/Serie 8



Descripción

- Tubo compuesto PP-RCT RA7050+ FV SDR17/SERIE 8.
- Capa externa: Capa PP-RCT aditivado con masterbath resistente a radiación UV color blanco.
- Capa interna: PP-RCT RA7050+FV color gris.
- Clase 1/4 bar, clase 2/4 bar, clase 4/4 bar.

Suministro:

- En barras de 5,8 metros.

Aplicaciones



Referencia	∅	Espesor (mm)	L (m)	Metros/Bolsa	Palet (m)	Precio (€/m)
27TNIRCLUV6317	63	3,8	2,4	23,2	510,4	16,72
27TNIRCLUV7517	75	4,5	3,4	17,4	348,0	19,65
27TNIRCLUV9017	90	5,4	4,9	11,6	232,0	28,17
27TNIRCLUV11017	110	6,6	7,4	5,8	162,4	42,09
27TNIRCLUV12517	125	7,4	9,5	5,8	116,0	53,59
27TNIRCLUV16017	160	9,5	5,8	5,8	69,6	112,97
27TNIRCLUV20017	200	11,9	5,8	5,8	46,4	196,01
27TNIRCLUV25017	250	14,9	5,8	5,8	29,0	282,46
27TNIRCLUV31517	315	18,7	5,8	5,8	17,4	421,80
27TNIRCLUV35517	355	21,1	5,8	5,8	17,4	530,36
27TNIRCLUV40017	400	23,7	5,8	5,8	17,4	674,42

Tubería compuesta NIRON CLIMA COOL PRO PP-RCT RA7050 CON PROTECCIÓN UV

Presiones de servicio tubería compuesta PP-RCT SDR17/Serie 8

NIRON Compuesto RP SDR17/Serie 8		
Clase		
	1	4
	2	4
	4	4
	5	-
T máxima fluido (°C)	Años en ejer. continuo	Presión servicio (bar)
Circuito cerrado		
10	1	14,4
	5	14,0
	10	13,8
	25	13,5
	50	13,4
20	1	12,5
	5	12,1
	10	12,0
	25	11,7
	50	11,6
30	1	10,8
	5	10,5
	10	10,3
	25	10,1
	50	10,0
40	1	9,3
	5	9,0
	10	8,8
	25	8,7
	50	8,5
50	1	8,0
	5	7,7
	10	7,5
	25	7,4
	50	7,2
60	1	6,7
	5	6,5
	10	6,4
	25	6,2
	50	6,1
70	1	5,7
	5	5,4
	10	5,3
	25	5,2
	50	5,1

Circuito cerrado: Coeficiente de seguridad aplicado del 1,25 según norma DIN 8077/78



Accesorios termofusión

Manguito unión socket



Características
Material: PP-RCT Protección UV.

Referencia	∅	Uds. Caja	Dn (mm)	D1 (mm)	D (mm)	L1 (mm)	L (mm)	Precio (€/ud.)
27NMANUV32	32 mm	40	32,0	30,0	46,0	20,0	43,0	1,92
27NMANUV40	40 mm	50	40,0	37,0	56,0	22,0	48,0	3,17
27NMANUV50	50 mm	20	50,0	47,0	70,0	25,0	54,0	4,87
27NMANUV63	63 mm	15	63,0	60,0	88,0	29,0	62,0	8,10

Codo 90° unión Socket



Características
Material: PP-RCT Protección UV.

Referencia	∅	Uds. Caja	Dn (mm)	D1 (mm)	D (mm)	L1 (mm)	L (mm)	H (mm)	Precio (€/ud.)
27NGUV32	32 mm	60	32,0	30,0	46,0	20,0	37,0	60,0	2,33
27NGUV40	40 mm	40	40,0	36,0	56,0	22,0	43,0	71,0	4,30
27NGUV50	50 mm	24	50,0	46,0	70,0	25,0	51,0	86,0	7,34
27NGUV63	63 mm	25	63,0	59,0	88,0	29,0	62,0	106,0	10,57

Accesorios termofusión

Codo 45° unión socket

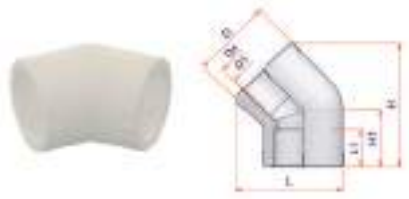

Características

Material: PP-RCT Protección UV.

Referencia	∅	Uds. Caja	Dn (mm)	D1 (mm)	D (mm)	L1 (mm)	L (mm)	H1 (mm)	H (mm)	Precio (€/ud.)
27NC45UV32	32 mm	40	32,0	30,0	42,0	20,0	56,0	29,0	64,0	2,57
27NC45UV40	40 mm	30	40,0	36,0	53,0	22,0	67,0	32,0	72,5	5,97
27NC45UV50	50 mm	30	50,0	47,5	66,0	25,0	83,6	39,5	90,0	10,63
27NC45UV63	63 mm	35	63,0	60,0	83,0	29,0	102,0	45,0	105,0	14,91

Te 90° unión socket



Características

Material: PP-RCT Protección UV.

Referencia	∅	Uds. Caja	Dn (mm)	D1 (mm)	D (mm)	L1 (mm)	L (mm)	H1 (mm)	H (mm)	Precio (€/ud.)
27NTUV32	32 mm	40	32,0	30,0	46,0	20,0	74,0	37,0	60,0	2,69
27NTUV40	40 mm	30	40,0	36,0	56,0	22,0	86,0	43,0	71,0	5,37
27NTUV50	50 mm	16	50,0	46,0	70,0	25,0	102,0	51,0	86,0	9,97
27NTUV63	63 mm	24	63,0	59,0	88,0	29,0	124,0	42,0	106,0	15,93

Accesorios termofusión

Enlace roscado hembra PP-RCT - SDR 11 soldadura a testa o accesorio eléctrico

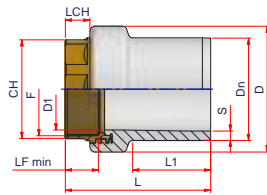

Características

Material: PP-RCT Protección UV - Latón.

Referencia	Ø x F	Uds. Caja	Dn (mm)	S	F	LFmin (mm)	D1 (mm)	D (mm)	L1 (mm)	L (mm)	CH (mm)	LCH (mm)	Precio (€/ud.)
27NRFFUV9321L *	32 x 1"	30	32	3,6	1"	21,0	24,0	50,0	48,0	91,0	38,0	13,0	37,98
7NRFFUV1140114L	40 x 1 1/4"	20	40	3,7	1 1/4"	21,0	31,0	64,0	53,0	100,0	46,0	15,0	43,83
27NRFFUV1150112L	50 x 1 1/2"	10	50	4,6	1 1/2"	19,0	38,0	70,0	61,0	108,0	55,0	15,0	48,37
27NRFFUV11632L	63 x 2"	7	63	5,8	2"	23,6	49,0	84,0	69,0	122,0	65,0	20,0	70,82
27NRFFUV1175212L	75 x 2 1/2"	9	75	6,8	2 1/2"	30,0	60,0	107,0	76,0	138,0	80,0	25,0	95,42
27NRFFUV11903L	90 x 3"	4	90	8,2	3"	33,3	71,0	119,0	87,0	153,0	95,0	24,0	194,95
27NRFFUV111104L	110 x 4"	2	110	10,0	4"	39,4	90,0	152,0	85,0	165,0	120,0	30,0	210,12
27NRFFUV111254L	125 x 4"	2	125	11,4	4"	39,4	99,0	153,0	95,0	117,0	120,0	30,0	242,01

* Fabricado en SDR9

Enlace roscado macho PP-RCT - SDR 11 soldadura a testa o accesorio eléctrico

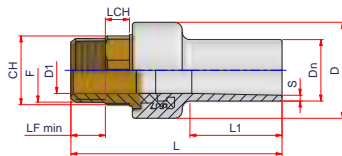

Características

Material: PP-RCT Protección UV - Latón.

Referencia	Ø x F	Uds. Caja	Dn (mm)	S	F	LFmin (mm)	D1 (mm)	D (mm)	L1 (mm)	L (mm)	CH (mm)	LCH (mm)	Precio (€/ud.)
27NRFMUV9321L *	32 x 1"	30	32	3,6	1"	16,8	24,0	50,0	48,0	110,0	34,0	13,0	45,56
27NRFMUV1140114L	40 x 1 1/4"	20	40	3,7	1 1/4"	19,0	31,0	63,0	53,0	124,0	42,0	15,0	50,46
27NRFMUV1150112L	50 x 1 1/2"	12	50	4,6	1 1/2"	19,0	38,0	70,0	61,0	131,0	50,0	15,0	52,84
27NRFMUV11632L	63 x 2"	6	63	5,8	2"	23,4	49,0	83,0	69,0	147,0	60,0	18,0	75,77
27NRFMUV1175212L	75 x 2 1/2"	4	75	6,8	2 1/2"	26,7	60,0	107,0	80,0	163,0	80,0	20,0	113,33
27NRFMUV11903L	90 x 3"	4	90	8,2	3"	30,0	71,0	118,0	87,0	183,0	90,0	23,0	216,87
27NRFMUV111104L	110 x 4"	2	110	10,0	4"	36,0	90,0	153,0	85,0	202,0	115,0	30,0	284,04
27NRFMUV111254L	125 x 4"	2	125	11,4	4"	36,0	99,0	153,0	95,0	214,0	115,0	30,0	319,15

* Fabricado en SDR9

Accesorios termofusión

Codo 90° - SDR11 soldadura a testa o accesorio eléctrico



Características

Accesorio inyectado para soldadura a tope o con accesorio electrosoldable.

Material: PP-RCT Protección UV.

Referencia	∅	Uds. Caja	Dn (mm)	S (mm)	L1 (mm)	L2 (mm)	H (mm)	Precio (€/ud.)
27NGUV901163MM	63 mm	50	63,0	5,8	70,0	120,0	154,0	28,48
27NGUV901175MM	75 mm	30	75,0	6,8	75,0	130,0	171,0	51,29
27NGUV901190MM	90 mm	24	90,0	8,2	90,0	148,5	197,0	79,77
27NGUV9011110MM	110 mm	12	110,0	10,0	87,0	160,0	221,0	102,52
27NGUV9011125MM	125 mm	24	125,0	11,4	95,0	184,0	250,0	113,93
27NGUV9011160MM	160 mm	10	160,0	14,6	110,0	217,0	303,0	120,50
27NGUV9011200MM	200 mm	30	200,0	18,2	117,0	250,0	356,5	318,97
27NGUV9011250MM	250 mm	8	250,0	22,7	135,0	305,0	435,0	567,13

Codo 90° segmentado - SDR11 soldadura a testa o accesorio eléctrico



Características

Accesorio segmentado para soldadura a tope o con accesorio electrosoldable.

Material: PP-RCT Protección UV.

Referencia	∅	Uds. Caja	Dn (mm)	S (mm)	L (mm)	Z (mm)	R (mm)	Precio (€/ud.)
27NGUV9011315MMB	315 mm	1	315,0	28,6	300,0	773,0	473,0	1.445,52
27NGUV9011355MMB	355 mm	1	355,0	32,2	300,0	833,0	533,0	1.819,67
27NGUV9011400MMB	400 mm	1	400,0	36,3	300,0	900,0	600,0	2.342,79

Accesorios termofusión

Codo 90° - SDR17 soldadura a testa o accesorio eléctrico



Características

Accesorio inyectado para soldadura a tope o con accesorio electrosoldable.

Material: PP-RCT Protección UV.

Referencia	∅	Uds. Caja	Dn (mm)	S (mm)	L1 (mm)	L2 (mm)	H (mm)	Precio (€/ud.)
27NGUV901763MM	63 mm	50	63,0	3,8	70,0	120,0	154,0	28,48
27NGUV901775MM	75 mm	30	75,0	4,5	75,0	130,0	171,0	51,29
27NGUV901790MM	90 mm	22	90,0	5,4	90,0	148,5	197,0	68,37
27NGUV9017110MM	110 mm	12	110,0	6,6	87,0	160,0	221,0	85,45
27NGUV9017125MM	125 mm	32	125,0	7,4	95,0	184,0	250,0	113,93
27NGUV9017160MM	160 mm	15	160,0	9,5	110,0	217,0	303,0	129,63
27NGUV9017200MM	200 mm	18	200,0	11,9	117,0	250,0	356,5	347,21
27NGUV9017250MM	250 mm	12	250,0	14,8	135,0	305,0	435,0	423,82

Codo 90° segmentado - SDR17 soldadura a testa o accesorio eléctrico



Características

Accesorio segmentado para soldadura a tope o con accesorio electrosoldable.

Material: PP-RCT Protección UV.

Referencia	∅	Uds. Caja	Dn (mm)	S (mm)	L (mm)	Z (mm)	R (mm)	Precio (€/ud.)
27NGUV9017315MMB	315 mm	1	315,0	18,7	300,0	773,0	473,0	1.164,59
27NGUV9017355MMB	355 mm	1	355,0	21,1	300,0	833,0	533,0	1.382,95
27NGUV9017400MMB	400 mm	1	400,0	23,7	300,0	900,0	600,0	1.965,24

Accesorios termofusión

Codo 45° - SDR11 soldadura a testa o accesorio eléctrico



Características

Accesorio inyectado para soldadura a tope o con accesorio electrosoldable.

Material: PP-RCT Protección UV.

Referencia	∅	Uds. Caja	Dn (mm)	S (mm)	L1 (mm)	L2 (mm)	H (mm)	Precio (€/ud.)
27NCUV451163MM	63 mm	60	63,0	5,8	70,0	90,0	175,0	28,48
27NCUV451175MM	75 mm	35	75,0	6,8	75,0	105,0	205,0	51,29
27NCUV451190MM	90 mm	22	90,0	8,2	90,0	120,0	235,0	79,77
27NCUV4511110MM	110 mm	12	110,0	10,0	87,0	120,0	243,0	102,52
27NCUV4511125MM	125 mm	32	125,0	11,4	95,0	130,0	265,0	131,00
27NCUV4511160MM	160 mm	15	160,0	14,6	105,0	160,0	328,0	116,20
27NCUV4511200MM	200 mm	18	200,0	18,2	117,0	195,0	402,0	307,63
27NCUV4511250MM	250 mm	12	250,0	22,7	135,0	220,0	462,0	546,83

Codo 45° segmentado - SDR11 soldadura a testa o accesorio eléctrico



Características

Accesorio segmentado para soldadura a tope o con accesorio electrosoldable.

Material: PP-RCT Protección UV.

Referencia	∅	Uds. Caja	Dn (mm)	S (mm)	L (mm)	Z (mm)	R (mm)	Precio (€/ud.)
27NCUV4511315MMB	315 mm	1	315,0	28,6	300,0	498,0	473,0	1.090,37
27NCUV4511355MMB	355 mm	1	355,0	32,2	300,0	520,0	533,0	1.362,94
27NCUV4511400MMB	400 mm	1	400,0	36,3	300,0	548,0	600,0	1.635,52

Accesorios termofusión

Codo 45° - SDR17 soldadura a testa o accesorio eléctrico



Características

Accesorio inyectado para soldadura a tope o con accesorio electrosoldable.

Material: PP-RCT Protección UV.

Referencia	∅	Uds. Caja	Dn (mm)	S (mm)	L1 (mm)	L2 (mm)	H (mm)	Precio (€/ud.)
27NCUV451763MM	63 mm	60	63,0	3,8	70,0	90,0	175,0	28,48
27NCUV451775MM	75 mm	35	75,0	4,5	75,0	105,0	205,0	51,29
27NCUV451790MM	90 mm	22	90,0	5,4	90,0	120,0	235,0	68,37
27NCUV4517110MM	110 mm	15	110,0	6,6	87,0	120,0	243,0	85,45
27NCUV4517125MM	125 mm	30	125,0	7,4	95,0	130,0	265,0	113,93
27NCUV4517160MM	160 mm	15	160,0	9,5	105,0	160,0	328,0	116,20
27NCUV4517200MM	200 mm	18	200,0	11,9	117,0	195,0	402,0	307,63
27NCUV4517250MM	250 mm	12	250,0	14,8	135,0	220,0	462,0	546,83

Codo 45° segmentado - SDR17 soldadura a testa o accesorio eléctrico



Características

Accesorio segmentado para soldadura a tope o con accesorio electrosoldable.

Material: PP-RCT Protección UV.

Referencia	∅	Uds. Caja	Dn (mm)	S (mm)	L (mm)	Z (mm)	R (mm)	Precio (€/ud.)
27NCUV4517315MMB	315 mm	1	315,0	18,7	300,0	498,0	473,0	991,19
27NCUV4517355MMB	355 mm	1	355,0	21,1	300,0	520,0	533,0	1.239,05
27NCUV4517400MMB	400 mm	1	400,0	23,7	300,0	548,0	600,0	1.486,90

Accesorios termofusión

Te - SDR11 soldadura a testa o accesorio eléctrico

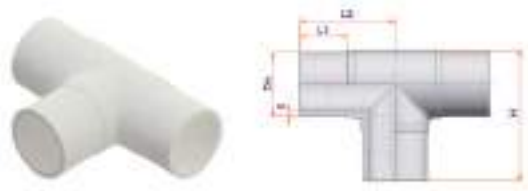

Características

Accesorio inyectado para soldadura a tope o con accesorio electrosoldable.

Material: PP-RCT Protección UV.

Referencia	Ø	Uds, Caja	Dn (mm)	S (mm)	L1 (mm)	L2 (mm)	H (mm)	Precio (€/ud,)
27NTUV1163MM	63 mm	30	63,0	5,8	70,0	120,0	154,0	34,15
27NTUV1175MM	75 mm	20	75,0	6,8	75,0	130,0	171,0	62,64
27NTUV1190MM	90 mm	15	90,0	8,2	90,0	149,0	197,0	108,25
27NTUV11110MM	110 mm	9	110,0	10,0	87,0	160,0	221,0	131,00
27NTUV11125MM	125 mm	5	125,0	11,4	95,0	185,0	250,0	165,22
27NTUV11160MM	160 mm	24	160,0	14,6	110,0	217,0	303,0	170,89
27NTUV11200MM	200 mm	12	200,0	18,2	117,0	250,0	357,0	444,30
27NTUV11250MM	250 mm	1	250,0	22,7	148,0	306,0	445,0	946,23

Te segmentado - SDR11 soldadura a testa o accesorio eléctrico



Características

Accesorio segmentado para soldadura a tope o con accesorio electrosoldable.

Material: PP-RCT Protección UV.

Referencia	Ø	Uds, Caja	Dn (mm)	S (mm)	L (mm)	Z (mm)	H (mm)	Precio (€/ud,)
27NTUV11315MMB	315 mm	1	315,0	28,6	300,0	460,0	615,0	1.455,73
27NTUV11355MMB	355 mm	1	355,0	32,2	300,0	480,0	655,0	2.183,60
27NTUV11400MMB	400 mm	1	400,0	36,3	300,0	500,0	700,0	2.838,68

Accesorios termofusión

Te - SDR17 soldadura a testa o accesorio eléctrico

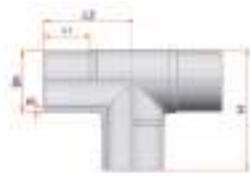

Características

Accesorio inyectado para soldadura a tope o con accesorio electrosoldable.

Material: PP-RCT Protección UV.

Referencia	Ø	Uds, Caja	Dn (mm)	S (mm)	L1 (mm)	L2 (mm)	H (mm)	Precio (€/ud,)
27NTUV1763MM	63 mm	30	63,0	3,8	70,0	120,0	154,0	31,35
27NTUV1775MM	75 mm	20	75,0	4,5	75,0	130,0	171,0	56,96
27NTUV1790MM	90 mm	16	90,0	5,4	90,0	149,0	197,0	96,85
27NTUV17110MM	110 mm	9	110,0	6,6	87,0	160,0	221,0	113,93
27NTUV17125MM	125 mm	5	125,0	7,4	95,0	185,0	250,0	142,41
27NTUV17160MM	160 mm	7	160,0	9,5	110,0	217,0	303,0	129,87
27NTUV17200MM	200 mm	5	200,0	11,9	117,0	250,0	357,0	405,49
27NTUV17250MM	250 mm	10	250,0	14,8	135,0	305,0	435,0	615,19

Te segmentado - SDR17 soldadura a testa o accesorio eléctrico

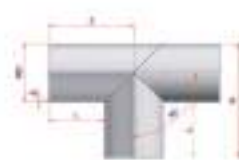

Características

Accesorio segmentado para soldadura a tope o con accesorio electrosoldable.

Material: PP-RCT Protección UV.

Referencia	Ø	Uds, Caja	Dn (mm)	S (mm)	L (mm)	Z (mm)	H (mm)	Precio (€/ud,)
27NTUV17315MMB	315 mm	1	315,0	18,7	300,0	460,0	615,0	1.091,80
27NTUV17355MMB	355 mm	1	355,0	21,1	300,0	480,0	655,0	1.455,73
27NTUV17400MMB	400 mm	1	400,0	23,7	300,0	500,0	700,0	1.819,67

Accesorios termofusión

Te reducida - SDR11 soldadura a testa o accesorio eléctrico



Características

Accesorio inyectado para soldadura a tope o con accesorio electrosoldable.

Material: PP-RCT Protección UV.

Referencia	∅	Uds. Caja	ND1 (mm)	ND1 (mm)	S1 (mm)	S2 (mm)	L1 (mm)	L2 (mm)	L (mm)	H1 (mm)	H (mm)	Precio (€/ud.)
27NTRUV1116063M160	160 x 63 x 160 mm	1	160,0	63,0	14,6	5,8	116,0	64,0	330,0	170,0	250,0	370,26
27NTRUV1116075M160	160 x 75 x 160 mm	1	160,0	75,0	14,6	6,8	116,0	82,0	348,0	178,0	258,0	370,26
27NTRUV1116090M160	160 x 90 x 160 mm	1	160,0	90,0	14,6	8,2	116,0	75,0	360,0	175,0	255,0	370,26
27NTRUV11160110M160	160 x 110 x 160 mm	1	160,0	110,0	14,6	10,0	116,0	85,0	390,0	180,0	260,0	370,26
27NTRUV11160125M160	160 x 125 x 160 mm	1	160,0	125,0	14,6	11,4	116,0	100,0	408,0	210,0	290,0	370,26
27NTRUV1120063M200	200 x 63 x 200 mm	1	200,0	63,0	18,2	5,8	139,0	64,0	376,0	190,0	290,0	436,72
27NTRUV1120075M200	200 x 75 x 200 mm	1	200,0	75,0	18,2	6,8	139,0	82,0	394,0	198,0	298,0	436,72
27NTRUV1120090M200	200 x 90 x 200 mm	1	200,0	90,0	18,2	8,2	139,0	75,0	406,0	195,0	295,0	436,72
27NTRUV11200110M200	200 x 110 x 200 mm	1	200,0	110,0	18,2	10,0	139,0	85,0	436,0	200,0	300,0	436,72
27NTRUV11200125M200	200 x 125 x 200 mm	1	200,0	125,0	18,2	11,4	139,0	100,0	453,0	230,0	330,0	436,72
27NTRUV11200160M200	200 x 160 x 200 mm	1	200,0	160,0	18,2	14,6	139,0	96,0	504,0	230,0	330,0	436,72
27NTRUV1125063M250	250 x 63 x 250 mm	1	250,0	63,0	22,7	5,8	159,0	64,0	416,0	215,0	340,0	740,53
27NTRUV1125075M250	250 x 75 x 250 mm	1	250,0	75,0	22,7	6,8	159,0	82,0	434,0	223,0	348,0	740,53
27NTRUV1125090M250	250 x 90 x 250 mm	1	250,0	90,0	22,7	8,2	159,0	75,0	446,0	220,0	345,0	740,53
27NTRUV11250110M250	250 x 110 x 250 mm	1	250,0	110,0	22,7	10,0	159,0	85,0	475,0	225,0	350,0	740,53
27NTRUV11250125M250	250 x 125 x 250 mm	1	250,0	125,0	22,7	11,4	159,0	100,0	493,0	255,0	380,0	740,53
27NTRUV11250160M250	250 x 160 x 250 mm	1	250,0	160,0	22,7	14,6	159,0	96,0	544,0	255,0	380,0	740,53
27NTRUV11250200M250	250 x 200 x 250 mm	1	250,0	200,0	22,7	18,2	159,0	190,0	565,0	350,0	475,0	968,38
27NTRUV1131563M315	315 x 63 x 315 mm	1	315,0	63,0	28,6	5,8	191,0	64,0	479,0	247,0	405,0	797,49
27NTRUV1131575M315	315 x 75 x 315 mm	1	315,0	75,0	28,6	6,8	191,0	82,0	497,0	256,0	413,0	797,49
27NTRUV1131590M315	315 x 90 x 315 mm	1	315,0	90,0	28,6	8,2	191,0	75,0	509,0	252,0	410,0	797,49
27NTRUV11315110M315	315 x 110 x 315 mm	1	315,0	110,0	28,6	10,0	191,0	85,0	538,0	258,0	415,0	1.367,12
27NTRUV11315125M315	315 x 125 x 315 mm	1	315,0	125,0	28,6	11,4	191,0	100,0	556,0	288,0	445,0	1.367,12
27NTRUV11315160M315	315 x 160 x 315 mm	1	315,0	160,0	28,6	14,6	191,0	96,0	607,0	288,0	445,0	1.367,12
27NTRUV11315200M315	315 x 200 x 315 mm	1	315,0	200,0	28,6	18,2	191,0	190,0	628,0	383,0	540,0	1.582,32
27NTRUV11315250M315	315 x 250 x 315 mm	1	315,0	250,0	28,6	22,7	191,0	190,0	682,0	383,0	540,0	1.719,89

Accesorios termofusión

Te reducida - SDR17 soldadura a testa o accesorio eléctrico

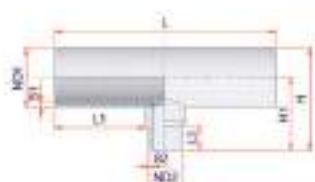

Características

Accesorio inyectado para soldadura a tope o con accesorio electrosoldable.

Material: PP-RCT Protección UV.

Referencia	∅	Uds. Caja	ND1 (mm)	ND1 (mm)	S1 (mm)	S2 (mm)	L1 (mm)	L2 (mm)	L (mm)	H1 (mm)	H (mm)	Precio (€/ud.)
27NTRUV1716063M160	160 x 63 x 160 mm	1	160,0	63,0	9,5	3,8	116,0	64,0	331,0	170,0	250,0	283,56
27NTRUV1716075M160	160 x 75 x 160 mm	1	160,0	75,0	9,5	4,5	116,0	82,0	348,0	178,0	260,0	283,56
27NTRUV1716090M160	160 x 90 x 160 mm	1	160,0	90,0	9,5	5,4	116,0	75,0	360,0	175,0	255,0	283,56
27NTRUV17160110M160	160 x 110 x 160 mm	1	160,0	110,0	9,5	6,6	116,0	85,0	390,0	180,0	260,0	283,56
27NTRUV17160125M160	160 x 125 x 160 mm	1	160,0	125,0	9,5	7,4	116,0	100,0	408,0	210,0	290,0	283,56
27NTRUV1720063M200	200 x 63 x 200 mm	1	200,0	63,0	11,9	3,8	139,0	64,0	376,0	190,0	290,0	412,78
27NTRUV1720075M200	200 x 75 x 200 mm	1	200,0	75,0	11,9	4,5	139,0	82,0	394,0	198,0	298,0	412,78
27NTRUV1720090M200	200 x 90 x 200 mm	1	200,0	90,0	11,9	5,4	139,0	75,0	406,0	195,0	295,0	412,78
27NTRUV17200110M200	200 x 110 x 200 mm	1	200,0	110,0	11,9	6,6	139,0	85,0	436,0	200,0	300,0	412,78
27NTRUV17200125M200	200 x 125 x 200 mm	1	200,0	125,0	11,9	7,4	139,0	100,0	453,0	230,0	330,0	412,78
27NTRUV17200160M200	200 x 160 x 200 mm	1	200,0	160,0	11,9	9,5	139,0	96,0	504,0	230,0	330,0	412,78
27NTRUV1725063M250	250 x 63 x 250 mm	1	250,0	63,0	14,8	3,8	159,0	64,0	416,0	215,0	340,0	632,93
27NTRUV1725075M250	250 x 75 x 250 mm	1	250,0	75,0	14,8	4,5	159,0	82,0	434,0	223,0	348,0	632,93
27NTRUV1725090M250	250 x 90 x 250 mm	1	250,0	90,0	14,8	5,4	159,0	75,0	446,0	220,0	345,0	632,93
27NTRUV17250110M250	250 x 110 x 250 mm	1	250,0	110,0	14,8	6,6	159,0	85,0	475,0	225,0	350,0	632,93
27NTRUV17250125M250	250 x 125 x 250 mm	1	250,0	125,0	14,8	7,4	159,0	100,0	493,0	255,0	380,0	632,93
27NTRUV17250160M250	250 x 160 x 250 mm	1	250,0	160,0	14,8	9,5	159,0	96,0	544,0	255,0	380,0	632,93
27NTRUV17250200M250	250 x 200 x 250 mm	1	250,0	200,0	14,8	11,9	159,0	190,0	565,0	350,0	475,0	822,81
27NTRUV1731563M315	315 x 63 x 315 mm	1	315,0	63,0	18,7	3,8	191,0	64,0	479,0	247,0	405,0	717,72
27NTRUV1731575M315	315 x 75 x 315 mm	1	315,0	75,0	18,7	4,5	191,0	82,0	497,0	256,0	413,0	717,72
27NTRUV1731590M315	315 x 90 x 315 mm	1	315,0	90,0	18,7	5,4	191,0	75,0	509,0	253,0	410,0	717,72
27NTRUV17315110M315	315 x 110 x 315 mm	1	315,0	110,0	18,7	6,6	191,0	85,0	538,0	258,0	415,0	1.230,39
27NTRUV17315125M315	315 x 125 x 315 mm	1	315,0	125,0	18,7	7,4	191,0	100,0	556,0	288,0	445,0	1.230,39
27NTRUV17315160M315	315 x 160 x 315 mm	1	315,0	160,0	18,7	9,5	191,0	96,0	607,0	288,0	445,0	1.230,39
27NTRUV17315200M315	315 x 200 x 315 mm	1	315,0	200,0	18,7	11,9	191,0	190,0	628,0	383,0	540,0	1.424,09
27NTRUV17315250M315	315 x 250 x 315 mm	1	315,0	250,0	18,7	14,8	191,0	190,0	683,0	383,0	540,0	1.547,93

Accesorios termofusión

Reducción - SDR11 soldadura a testa o con accesorio eléctrico

A

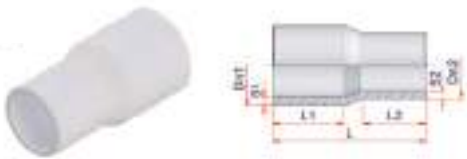

B

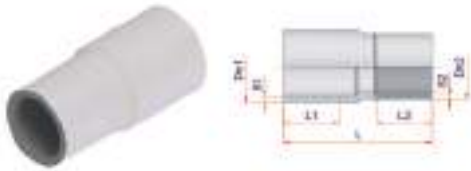

Características

Soldadura a tope o con accesorio electrosoldable.

Material: PP-RCT Protección UV.

Tipo A: Inyectado.

Tipo B: Segmentado.

Referencia	Tipo	∅	Uds. Caja	Dn1 (mm)	S1 (mm)	Dn2 (mm)	S2 (mm)	L1 (mm)	L2 (mm)	L (mm)	Precio (€/ud.)
27NRUV754011MM	A	75/40 mm	20	75,0	6,8	40,0	3,7	65,0	48,0	143,0	21,20
27NRUV755011MM	A	75/50 mm	16	75,0	6,8	50,0	4,6	65,0	48,0	141,0	21,20
27NRUV756311MM	A	75/63 mm	12	75,0	6,8	63,0	5,8	71,0	64,0	150,0	21,20
27NRUV905011MM	A	90/50 mm	12	90,0	8,2	50,0	4,6	73,0	57,0	152,0	36,54
27NRUV906311MM	A	90/63 mm	12	90,0	8,2	63,0	5,8	71,0	57,0	150,0	36,54
27NRUV907511MM	A	90/75 mm	9	90,0	8,2	75,0	6,8	81,0	72,0	175,0	36,54
27NRUV1106311MM	A	110/63 mm	8	110,0	10,0	63,0	5,8	85,0	70,0	175,0	47,53
27NRUV1107511MM	A	110/75 mm	6	110,0	10,0	75,0	6,8	88,0	58,0	185,0	47,53
27NRUV1109011MM	A	110/90 mm	6	110,0	10,0	90,0	8,2	78,0	70,0	175,0	47,53
27NRUV1257511MM	A	125/75 mm	3	125,0	11,4	75,0	6,8	92,0	60,0	199,0	64,73
27NRUV1259011MM	A	125/90 mm	4	125,0	11,4	90,0	8,2	86,0	70,0	186,0	64,73
27NRUV12511011MM	A	125/110 mm	20	125,0	11,4	110,0	10,0	89,0	77,0	187,0	64,73
27NRUV1609011MM	A	160/90 mm	12	160,0	14,6	90,0	8,2	107,0	90,0	230,0	109,21
27NRUV16011011MM	A	160/110 mm	12	160,0	14,6	110,0	10,0	103,0	88,0	315,0	109,21
27NRUV16012511MM	A	160/125 mm	40	160,0	14,6	125,0	11,4	102,0	91,0	214,0	145,57
27NRUV20016011MM	A	200/160 mm	22	200,0	18,1	160,0	14,6	118,0	101,0	240,0	160,14
27NRUV25016011MMB	B	250/160 mm	1	250,0	22,7	160,0	14,6	245,0	175,0	500,0	509,51
27NRUV25020011MMB	B	250/200 mm	2	250,0	22,7	200,0	18,2	245,0	185,0	510,0	509,51
27NRUV31516011MMB	B	315/160 mm	1	315,0	28,6	160,0	14,6	320,0	175,0	575,0	655,08
27NRUV31520011MMB	B	315/200 mm	1	315,0	28,6	200,0	18,2	320,0	185,0	585,0	655,08
27NRUV31525011MMB	B	315/250 mm	1	315,0	28,6	250,0	22,7	320,0	212,0	612,0	727,87
27NRUV35520011MMB	B	355/200 mm	1	355,0	32,3	200,0	18,2	320,0	185,0	585,0	1.819,67
27NRUV35525011MMB	B	355/250 mm	1	355,0	32,3	250,0	22,7	320,0	212,0	612,0	1.965,24
27NRUV35531511MMB	B	355/315 mm	1	355,0	32,3	315,0	28,6	320,0	320,0	740,0	2.110,81
27NRUV40025011MMB	B	400/250 mm	1	400,0	36,2	250,0	22,7	320,0	320,0	632,0	2.329,17
27NRUV40031511MMB	B	400/315 mm	1	400,0	36,2	315,0	28,6	320,0	320,0	740,0	2.474,75
27NRUV40035511MMB	B	400/355 mm	1	400,0	36,2	355,0	32,3	320,0	320,0	740,0	2.620,32

Accesorios termofusión

Reducción - SDR17 soldadura a testa o con accesorio eléctrico

A

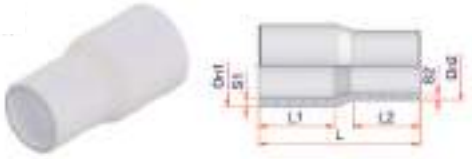

B



Características

Soldadura a tope o con accesorio electrosoldable.

Material: PP-RCT Protección UV.

Tipo A: Inyectado.

Tipo B: Segmentado.

Referencia	Tipo	Ø	Uds. Caja	Dn1 (mm)	S1 (mm)	Dn2 (mm)	S2 (mm)	L1 (mm)	L2 (mm)	L (mm)	Precio (€/ud.)
27NRUV754017MM	A	75/40 mm	1	75,0	4,5	40,0	2,3	65,0	48,0	143,0	17,97
27NRUV755017MM	A	75/50 mm	1	75,0	4,5	50,0	3,0	65,0	48,0	141,0	17,97
27NRUV756317MM	A	75/63 mm	14	75,0	4,5	63,0	3,8	71,0	64,0	150,0	17,97
27NRUV905017MM	A	90/50 mm	18	90,0	5,4	50,0	3,0	73,0	57,0	152,0	31,05
27NRUV906317MM	A	90/63 mm	78	90,0	5,4	63,0	3,8	71,0	57,0	150,0	31,05
27NRUV907517MM	A	90/75 mm	12	90,0	5,4	75,0	4,5	81,0	72,0	175,0	31,05
27NRUV1106317MM	A	110/63 mm	45	110,0	6,6	63,0	3,8	85,0	70,0	175,0	40,42
27NRUV1107517MM	A	110/75 mm	6	110,0	6,6	75,0	4,5	88,0	58,0	185,0	40,42
27NRUV1109017MM	A	110/90 mm	45	110,0	6,6	90,0	5,4	78,0	70,0	175,0	40,42
27NRUV1257517MM	A	125/75 mm	3	125,0	7,4	75,0	4,5	92,0	60,0	199,0	54,99
27NRUV1259017MM	A	125/90 mm	4	125,0	7,4	90,0	5,4	86,0	70,0	186,0	54,99
27NRUV12511017MM	A	125/110 mm	20	125,0	7,4	110,0	6,6	89,0	77,0	187,0	54,99
27NRUV1609017MM	A	160/90 mm	40	160,0	9,5	90,0	5,4	107,0	90,0	230,0	94,64
27NRUV16011017MM	A	160/110 mm	12	160,0	9,5	110,0	6,6	103,0	88,0	215,0	94,64
27NRUV16012517MM	A	160/125 mm	12	160,0	9,5	125,0	7,4	120,0	91,0	214,0	131,00
27NRUV20016017MM	A	200/160 mm	60	200,0	11,9	160,0	9,5	118,0	101,0	240,0	145,57
27NRUV25016017MMB	B	250/160 mm	1	250,0	14,8	160,0	9,5	245,0	175,0	500,0	509,51
27NRUV25020017MMB	B	250/200 mm	1	250,0	14,8	200,0	11,9	245,0	185,0	510,0	509,51
27NRUV31516017MMB	B	315/160 mm	1	315,0	18,7	160,0	9,5	250,0	175,0	505,0	655,08
27NRUV31520017MMB	B	315/200 mm	1	315,0	18,7	200,0	11,9	250,0	185,0	515,0	655,08
27NRUV31525017MMB	B	315/250 mm	1	315,0	18,7	250,0	14,8	250,0	245,0	575,0	727,87
27NRUV35520017MMB	B	355/200 mm	1	355,0	21,1	200,0	11,9	320,0	185,0	585,0	1.819,67
27NRUV35525017MMB	B	355/250 mm	1	355,0	21,1	250,0	14,8	320,0	245,0	645,0	1.965,24
27NRUV35531517MMB	B	355/315 mm	1	355,0	21,1	315,0	18,7	320,0	250,0	650,0	2.110,81
27NRUV40025017MMB	B	400/250 mm	1	400,0	23,7	250,0	14,8	320,0	245,0	645,0	2.329,17
27NRUV40031517MMB	B	400/315 mm	1	400,0	23,7	315,0	18,7	320,0	250,0	650,0	2.474,75
27NRUV40035517MMB	B	400/355 mm	1	400,0	23,7	355,0	21,1	320,0	320,0	720,0	2.620,32

Accesorios termofusión

Tapón largo - SDR11 soldadura a testa o accesorio eléctrico



Características

Soldadura a tope o con accesorio electrosoldable.

Material: PP-RCT Protección UV.

Tipo A: Inyectado.

Tipo B: Segmentado.

Referencia	Tipo	∅	Uds. Caja	Dn (mm)	S (mm)	L1 (mm)	L (mm)	Precio (€/ud.)
27NCCUV6311M	A	63 mm	70	63,0	5,8	70,0	87,0	17,08
27NCCUV7511M	A	75 mm	30	75,0	6,8	75,0	95,0	25,08
27NCCUV9011M	A	90 mm	30	90,0	8,2	81,0	105,0	56,96
27NCCUV11011M	A	110 mm	40	110,0	10,0	90,0	119,0	68,37
27NCCUV12511M	A	125 mm	24	125,0	11,4	95,0	128,0	104,79
27NCCUV16011M	A	160 mm	16	160,0	14,6	108,0	142,0	113,93
27NCCUV20011M	A	200 mm	24	200,0	18,2	133,0	172,0	133,51
27NCCUV25011MB	B	250 mm	1	250,0	22,7	222,0	292,0	632,93
27NCCUV31511MB	B	315 mm	1	315,0	28,8	320,0	400,0	949,39
27NCCUV35511MB	B	355 mm	1	355,0	32,2	320,0	400,0	2.151,95
27NCCUV40011MB	B	400 mm	1	400,0	36,3	320,0	420,0	2.278,54

Tapón largo - SDR17 soldadura a testa o accesorio eléctrico

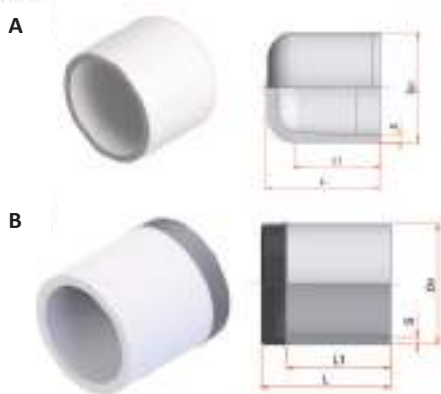

Características

Soldadura a tope o con accesorio electrosoldable.

Material: PP-RCT Protección UV.

Tipo A: Inyectado.

Tipo B: Segmentado.

Referencia	Tipo	∅	Uds. Caja	Dn (mm)	S (mm)	L1 (mm)	L (mm)	Precio (€/ud.)
27NCCUV6317M	A	63 mm	1	63,0	3,8	70,0	87,0	14,81
27NCCUV7517M	A	75 mm	45	75,0	4,5	75,0	95,0	22,81
27NCCUV9017M	A	90 mm	30	90,0	5,4	81,0	105,0	51,29
27NCCUV11017M	A	110 mm	18	110,0	6,6	88,0	116,0	62,64
27NCCUV12517M	A	125 mm	24	125,0	7,4	95,0	128,0	96,85
27NCCUV16017M	A	160 mm	40	160,0	9,5	108,0	142,0	107,60
27NCCUV20017M	A	200 mm	24	200,0	11,9	136,0	169,0	126,59
27NCCUV25017MB	B	250 mm	1	250,0	14,8	222,0	292,0	632,93
27NCCUV31517MB	B	315 mm	1	315,0	18,7	320,0	400,0	949,39
27NCCUV35517MB	B	355 mm	1	355,0	21,1	320,0	400,0	2.151,95
27NCCUV40017MB	B	400 mm	1	400,0	23,1	320,0	420,0	2.278,54

Portabridas

Portabridas con junta tórica unión socket

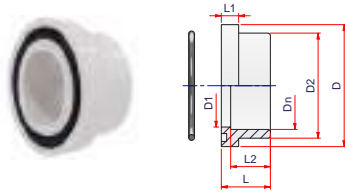

Características

Material: PP-RCT Protección UV.

Referencia	∅	Uds, Caja	Dn (mm)	D (mm)	D1 (mm)	D2 (mm)	L1 (mm)	L2 (mm)	L (mm)	Precio (€/ud,)
27NCOSAUUV32	32 mm	100	32,0	51,0	28,0	41,0	10,0	20,0	26,0	4,69
27NCOSAUUV40	40 mm	50	40,0	64,0	36,0	50,0	13,0	22,0	30,0	5,34
27NCOSAUUV50	50 mm	36	50,0	73,0	45,5	61,0	13,0	26,0	34,0	5,86
27NCOSAUUV63	63 mm	20	63,0	90,0	56,0	76,0	14,0	30,0	38,0	9,56

Portabridas largo - SDR11 soldadura a testa o accesorio eléctrico



Características

Soldadura a tope o con accesorio electrosoldable.

Material: PP-RCT Protección UV.

Tipo A: Inyectado.

Tipo B: Segmentado.

Referencia	Tipo	∅	Uds. Caja	Dn (mm)	S (mm)	D (mm)	D1 (mm)	L1 (mm)	L2 (mm)	L (mm)	B (mm)	α (mm)	Precio (€/ud,)
27NCRUV6311	A	63 mm	30	63,0	5,8	102,0	74,0	70,0	17,0	114,0	64,0	70°	17,07
27NCRUV7511	A	75 mm	20	75,0	6,8	122,0	89,0	77,0	17,0	118,0	72,0	79°	35,87
27NCRUV9011	A	90 mm	30	90,0	8,2	138,0	105,0	94,0	18,0	130,0	88,0	70°	41,02
27NCRUV11011	A	110 mm	48	110,0	10,0	160,0	125,0	93,0	19,0	133,0	109,0	68°	64,25
27NCRUV12511	A	125 mm	40	125,0	11,4	160,0	132,0	97,0	20,0	143,0	112,0	78°	74,04
27NCRUV16011	A	160 mm	24	160,0	14,6	212,0	174,0	105,0	24,0	180,0	158,0	65°	102,60
27NCRUV20011	A	200 mm	12	200,0	18,2	268,0	230,0	128,0	29,0	197,0	208,0	65°	156,56
27NCRUV25011	A	250 mm	18	250,0	22,9	318,0	283,0	120,0	34,0	195,0	259,0	65°	410,15
27NCARTUV31511	A	315 mm	1	315,0	28,8	370,0	335,0	130,0	35,0	205,0	310,0	68°	497,50
27NCARTUV35511MB	B	355 mm	1	355,0	32,2	430,0	371,0	320,0	39,0	470,0	340,0	68°	1.932,22
27NCARTUV40011MB	B	400 mm	1	400,0	36,3	482,0	424,0	320,0	45,0	475,0	390,0	65°	2.345,04

Portabridas

Portabridas largo - SDR17 soldadura a testa o accesorio eléctrico



Características

Soldadura a tope o con accesorio electrosoldable.
Material: PP-RCT Protección UV.
Tipo A: Inyectado.
Tipo B: Segmentado.

Referencia	Tipo	∅	Uds. Caja	Dn (mm)	S (mm)	D (mm)	D1 (mm)	L1 (mm)	L2 (mm)	L (mm)	B (mm)	α (mm)	Precio (€/ud.)
27NCRTUV7517	A	75 mm	48	75,0	4,5	122,0	89,0	77,0	17,0	118,0	74,0	80°	28,48
27NCRTUV9017	A	90 mm	30	90,0	5,4	138,0	105,0	82,0	17,0	130,0	90,0	75°	41,02
27NCRTUV11017	A	110 mm	60	110,0	6,6	158,0	125,0	92,0	18,0	131,0	110,0	68°	61,26
27NCRTUV12517	A	125 mm	40	125,0	7,4	160,0	132,0	97,0	20,0	143,0	115,0	79°	74,04
27NCRTUV16017	A	160 mm	24	160,0	9,5	212,0	174,0	105,0	24,0	180,0	158,0	65°	62,87
27NCRTUV20017	A	200 mm	12	200,0	11,9	268,0	230,0	128,0	29,0	197,0	208,0	65°	157,22
27NCRTUV25017	A	250 mm	1	250,0	14,8	318,0	290,0	120,0	34,0	195,0	259,0	70°	341,78
27NCARTUV31517	A	315 mm	1	315,0	18,7	370,0	335,0	130,0	35,0	205,0	310,0	68°	632,09
27NCARTUV35517MB	B	355 mm	1	355,0	21,1	430,0	370,0	320,0	37,0	470,0	340,0	68°	1.852,79
27NCARTUV40017MB	B	400 mm	1	400,0	23,7	482,0	424,0	320,0	33,0	475,0	394,0	68°	2.309,42

Junta plana de caucho sintético EPDM

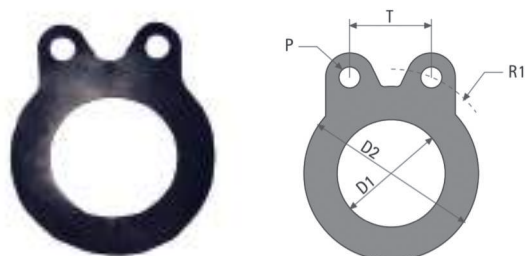

Referencia	∅ Tubería (mm)	Tipo	Uds. Caja	DN goma (mm)	D1 (mm)	D2 (mm)	Sp (mm)	∅ P (mm)	R1 (mm)	R2 (mm)	∅ S (mm)	T (mm)	T1 (mm)	T2 (mm)	Precio (€/u.)
EGR 63	63	A	1	50	60	96	3	15	61	-	-	87	-	-	2,44
EGR 75	75	A	1	65	77	121	3	18	71	-	-	93	-	-	2,44
EGR 90	90	A	1	80	80	130	3	16	78	-	-	61	-	-	2,78
EGR 110	110	A	1	100	100	154	3	16	88	-	-	68	-	-	3,26
EGR 125	125	A	1	100	100	154	3	16	88	-	-	68	-	-	3,39
EGR 140	140	A	1	125	125	183	3	16	107	-	-	81	-	-	5,84
EGR 160	160	A	1	150	150	208	3	20	118	-	-	91	-	-	6,29
EGR 180	180	A	1	150	150	208	3	20	118	-	-	91	-	-	6,29
EGR 200	200	A	1	200	200	263	3	20	146	-	-	75	-	-	10,08
EGR 225	225	A	1	200	200	263	3	20	146	-	-	75	-	-	10,08
EGR 250	250	A	1	250	250	316	4	24	176	-	-	91	-	-	13,26
EGR 280	280	A	1	250	250	316	4	24	176	-	-	91	-	-	13,26
EGR 315	315	A	1	300	300	367	4	24	203	-	-	105	-	-	17,75
EGR 355	355	A	1	350	350	425	4	24	233	-	-	91	-	-	Consultar
EGR 400	400	A	1	400	400	477	4	24	261	-	-	102	-	-	Consultar

Bridas

Brida de aluminio PN16 para portabridas soldadura socket, soldadura a testa o accesorio eléctrico. Sistema métrico EN 1092



Referencia	Ø Tubería	DN	Ø Interior brida (mm)	Ø Exterior brida (mm)	Uds, Caja	Nº agujeros	Distancia agujeros (mm)	Ø agujeros (mm)	Para conexión con válvula	PN	Precio (€/ud.)
SOCKET											
NFLA32	32 mm	25	45,0	115,0	1	4	85,0	14,0	1"	10/16	18,43
NFLA40	40 mm	32	51,0	140,0	1	4	100,0	18,0	1 1/4"	10/16	32,17
NFLA50	50 mm	40	62,0	150,0	1	4	110,0	18,0	1 1/2"	10/16	34,76
NFLA63	63 mm	50	78,0	165,0	1	4	125,0	18,0	2"	10/16	39,17
SOLDADURA A TESTA											
E7163	63 mm	50	78,0	165,0	1	4	125,0	18	2"	16	35,57
E7164	75 mm	65	92,0	185,0	1	4	145,0	18	2 1/2"	16	47,94
E7165	90 mm	80	108,0	200,0	1	8	160,0	18	3"	16	54,43
E7166	110 mm	100	128,0	220,0	1	8	180,0	18	4"	16	58,01
E7167	125 mm	100	135,0	220,0	1	8	180,0	18	4"	16	61,07
NFLA160	160 mm	150	178,0	285,0	1	8	240,0	22,0	6"	10/16	104,23
NFLA20016	200 mm	200	238,0	340,0	1	12	295,0	22,0	8"	16	165,25

Brida de aluminio PN10 para portabridas soldadura a testa o con accesorio eléctrico. Sistema métrico EN 1092



Referencia	Ø Tubería	DN	Ø Interior brida (mm)	Ø Exterior brida (mm)	Uds. Caja	Nº agujeros	Distancia agujeros (mm)	Ø agujeros (mm)	Para conexión con válvula	PN	Precio (€/ud.)
NFLA20010	200 mm	200	238,0	340,0	1	8	295,0	22,0	8"	10	165,25
NFLA250	250 mm	250	288,0	395,0	1	12	350,0	22,0	10"	10	219,23
NFLA315	315 mm	300	338,0	445,0	1	12	400,0	22,0	12"	10	363,93
NFLA355	355 mm	350	376,0	505,0	1	16	460,0	22,0	14"	10	588,92
NFLA400	400 mm	400	430,0	565,0	1	16	515,0	25,0	16"	10	611,15

Bridas

Brida de acero con revestimiento de PP para portabridas soldadura socket, soldadura a testa o con accesorio eléctrico.
Sistema métrico EN 1092

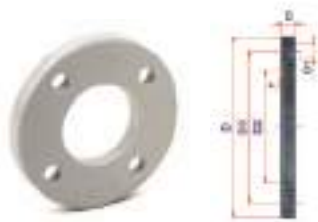

Referencia	Ø Tubería	DN	Ø Interior brida (mm)	Ø Exterior brida (mm)	Uds. Caja	Nº agujeros	Distancia agujeros (mm)	Ø agujeros (mm)	Para conexión con válvula	PN	Precio (€/ud.)
SOCKET											
NFLA32PP	32 mm	25	42,0	115,0	1	4	85,0	14,0	1"	10/16	19,46
NFLA40PP	40 mm	32	51,0	140,0	1	4	100,0	18,0	1 1/4"	10/16	26,53
NFLA50PP	50 mm	40	62,0	150,0	1	4	110,0	18,0	1 1/2"	10/16	30,48
NFLA63PP	63 mm	50	78,0	165,0	1	4	125,0	18,0	2"	10/16	36,39
SOLDADURA A TESTA											
E7163PP	63 mm	50	78,0	165,0	1	4	125,0	18,0	-	10/16	33,51
E7164PP	75 mm	65	92,0	186,0	1	4	145,0	18,0	-	10/16	39,53
E7165PP	90 mm	80	108,0	202,0	1	8	160,0	18,0	-	10/16	51,16
E7166PP	110 mm	100	128,0	220,0	1	8	180,0	18,0	-	10/16	64,90
E7167PP	125 mm	100	135,0	220,0	1	8	180,0	18,0	-	10/16	69,50
NFLA160PP	160 mm	150	178,0	285,0	1	8	240,0	22,0	6"	10/16	121,19
NFLA200PP	200 mm	200	235,0	340,0	1	8	295,0	22,0	8"	10	179,01
NFLA200PP16	200 mm	200	235,0	340,0	1	12	295,0	22,0	8"	16	170,88
NFLA250PP	250 mm	250	288,0	409,0	1	12	350,0	22,0	10"	10	232,31
NFLA250PP16	250 mm	250	288,0	418,0	1	12	355,0	26,0	10"	16	268,36
NFLA315PP	315 mm	300	338,0	463,0	1	12	400,0	23,0	12"	10	321,91
NFLA315PP16	315 mm	300	338,0	478,0	1	12	410,0	26,0	12"	16	340,22
NFLA355PP	355 mm	350	376,0	515,0	1	16	460,0	22,5	14"	10	539,78
NFLA355PP16	355 mm	350	376,0	530,0	1	16	470,0	26,0	14"	16	619,15
NFLA400PP	400 mm	400	430,0	574,0	1	16	515,0	26,0	16"	10	562,53
NFLA400PP16	400 mm	400	430,0	599,0	1	16	525,0	30,0	16"	16	684,28

La empresa fabricante se reserva el derecho de cambio de color del revestimiento de PP.

Accesorios electrosoldables

Manguito SDR7,3 - SDR11 soldadura eléctrica

A



B

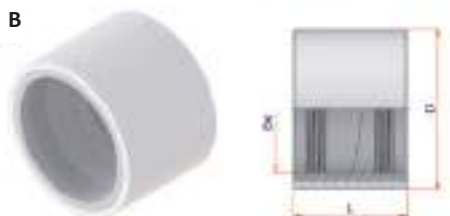

Características

Material: PP-RCT Protección UV.

Referencia	Tipo	SDR	Ø	Uds. Caja	Dn (mm)	L1 (mm)	L (mm)	H (mm)	D (mm)	Precio (€/ud.)
27NMEUV3273	A	7,3	32 mm	1	32,0	34,0	70,0	65,0	45,0	20,48
27NMEUV4073	A	7,3	40 mm	1	40,0	41,0	85,0	75,0	55,0	22,93
27NMEUV5073	A	7,3	50 mm	50	50,0	42,0	88,0	87,0	68,0	24,96
27NMEUV6373	A	7,3	63 mm	30	63,0	48,0	98,0	98,0	80,0	29,38
27NMEUV7573	A	7,3	75 mm	24	75,0	61,0	125,0	114,0	98,0	51,89
27NMEUV9011	A	11	90 mm	30	90,0	72,0	146,0	130,0	113,0	58,28
27NMEUV11011	A	11	110 mm	22	110,0	77,0	155,0	144,0	136,0	62,58
27NMEUV12511	A	11	125 mm	16	125,0	82,0	166,0	167,0	157,0	115,60
27NMEUV16011	A	11	160 mm	24	160,0	87,0	175,0	201,0	190,0	152,98
27NMEUV20011	A	11	200 mm	14	200,0	91,0	185,0	243,0	232,0	271,80
27NMEUV25011	A	11	250 mm	32	250,0	106,0	212,0	300,0	296,0	567,13
27NMEUV31511	B	11	315 mm	1	315,0	-	320,0	-	396,0	987,73
27NMEUV35511	B	11	355 mm	1	355,0	-	320,0	-	450,0	2.019,04
27NMEUV40011	B	11	400 mm	1	400,0	-	320,0	-	500,0	2.315,92

Accesorios electrosoldables

Codo 90° SDR11 soldadura eléctrica



Características
Material: PP-RCT Protección UV.

Referencia	Tipo	∅	Uds. Caja	Dn (mm)	L1 (mm)	L2 (mm)	L (mm)	H (mm)	Precio (€/ud.)
27NGEMUV32	A	32 mm	50	32,0	34,0	57,0	64,0	80,0	72,13
27NGEMUV40	A	40 mm	50	40,0	41,0	65,0	73,0	91,0	76,01
27NGEMUV50	A	50 mm	30	50,0	48,0	77,0	84,0	109,0	80,31
27NGEMUV63	A	63 mm	15	63,0	53,0	88,0	100,0	129,0	99,00
27NGEMUV75	A	75 mm	12	75,0	58,0	97,0	110,0	142,0	129,99
27NGEMUV90	A	90 mm	14	90,0	78,0	119,0	133,0	176,0	150,89
27NGEMUV110	A	110 mm	10	110,0	83,0	144,0	164,0	214,0	237,59
27NGEMUV125	A	125 mm	6	125,0	88,0	157,0	180,0	237,0	484,85
27NGEMUV160	B	160 mm	1	160,0	90,0	173,0	209,0	269,0	528,32
27NGEMUV200	B	200 mm	5	200,0	103,0	213,0	254,0	334,0	1.027,19

Codo 45° SDR11 soldadura eléctrica



Características
Material: PP-RCT Protección UV.

Referencia	Tipo	∅	Uds. Caja	Dn (mm)	L1 (mm)	L2 (mm)	L (mm)	H (mm)	Precio (€/ud.)
27NCEMUV32	A	32 mm	80	32,0	36,0	47,0	65,0	94,0	72,13
27NCEMUV40	A	40 mm	50	40,0	41,0	54,0	75,0	109,0	63,71
27NCEMUV50	A	50 mm	34	50,0	48,0	63,0	83,0	128,0	71,71
27NCEMUV63	A	63 mm	20	63,0	54,0	68,0	100,0	146,0	89,86
27NCEMUV75	A	75 mm	14	75,0	60,0	81,0	113,0	169,0	113,99
27NCEMUV90	A	90 mm	16	90,0	67,0	97,0	132,0	219,0	150,89
27NCEMUV110	A	110 mm	12	110,0	81,0	107,0	152,0	241,0	279,86
27NCEMUV125	A	125 mm	8	125,0	85,0	122,0	157,0	246,0	401,25
27NCEMUV160	B	160 mm	12	160,0	90,0	134,0	209,0	295,0	528,32
27NCEMUV200	B	200 mm	5	200,0	98,0	167,0	250,0	368,0	1.027,19

Accesorios electrosoldables

Te SDR11 soldadura eléctrica

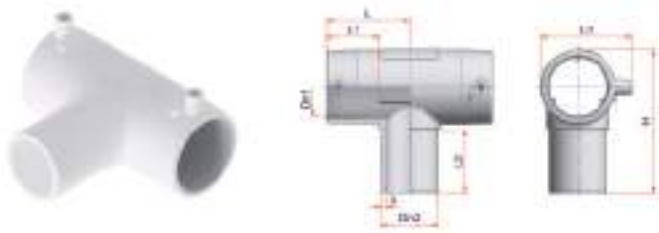

Características
Material: PP-RCT Protección UV.

Referencia	∅	Uds. Caja	Dn1 (mm)	Dn2 (mm)	S (mm)	L1 (mm)	L2 (mm)	L (mm)	H (mm)	Precio (€/ud.)
27NTCEUV32	32 mm	50	32,0	32,0	3,0	38,0	47,0	64,0	55,0	29,80
27NTCEUV40	40 mm	30	40,0	40,0	3,7	44,0	54,0	74,0	67,0	89,62
27NTCEUV50	50 mm	20	50,0	50,0	4,6	46,0	61,0	85,0	77,0	119,78
27NTCEUV63	63 mm	12	63,0	63,0	5,8	57,0	68,0	99,0	90,0	130,17
27NTCEUV75	75 mm	20	75,0	75,0	6,8	58,0	72,0	112,0	98,0	142,65
27NTCEUV90	90 mm	11	90,0	90,0	8,2	70,0	84,0	140,0	122,0	299,09
27NTCEUV110	110 mm	7	110,0	110,0	10,0	83,0	88,0	157,0	144,0	388,47
27NTCEUV125	125 mm	5	125,0	125,0	11,4	88,0	94,0	174,0	158,0	525,03
27NTCEUV160	160 mm	8	160,0	160,0	14,6	87,0	105,0	205,0	151,0	584,98

Reducción SDR11 soldadura eléctrica



Características
Material: PP-RCT Protección UV.

Referencia	∅	Uds. Caja	Dn1 (mm)	Dn2 (mm)	D (mm)	L1 (mm)	L2 (mm)	L (mm)	H (mm)	Precio (€/ud.)
27NRDEUV4032	40/32 mm	20	40,0	32,0	55,0	47,0	42,0	95,0	74,0	40,84
27NRDEUV5032	50/32 mm	20	50,0	32,0	64,0	50,0	42,0	100,0	85,0	44,66
27NRDEUV5040	50/40 mm	10	50,0	40,0	64,0	50,0	48,0	103,0	85,0	44,66
27NRDEUV6332	63/32 mm	16	63,0	32,0	82,0	56,0	42,0	118,0	99,0	96,37
27NRDEUV6340	63/40 mm	18	63,0	40,0	82,0	55,0	45,0	118,0	99,0	50,99
27NRDEUV6350	63/50 mm	18	63,0	50,0	82,0	56,0	50,0	118,0	99,0	96,37

italsan

Italsan Customer Service
atencionalcliente@italsan.com

www.ital-san.com

Sede Madrid

Tel. (+34) 918 060 723

Oficinas y Almacén

Coto de Doñana, 21
28320 Pinto - Madrid

Sede Barcelona

Tel. (+34) 936 303 040

Italsantech

C/ de la Màquina, 8B
Pol. Ind. El Regàs
08850 Gavà - Barcelona

Sede Barcelona

Tel. (+34) 936 303 040

Centro logístico

C/ Progrés, 29
Pol. Ind. Les Massotes
08850 Gavà - Barcelona

ITALSAN no se responsabiliza de posibles errores que aparezcan en la presente tarifa, y se reserva el derecho de modificar sin previo aviso las características y precios* de los productos.

Para cualquier consulta dirigirse a atencionalcliente@ital-san.com

*Precios sin IVA.

Distribuido por:



TARANIRONCOOLPRO/2023/09